



Options and Accessories

Shafts and Flanges for Non-RediMount™ Units

T60

T06SXXXXB25

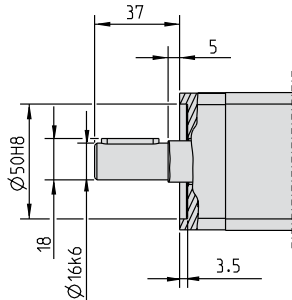

T06SXXXXG25

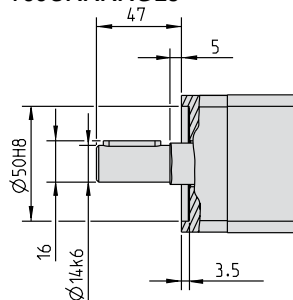

T06SXXXXH25

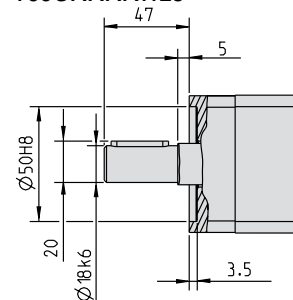

T06SXXXXB/G/H25

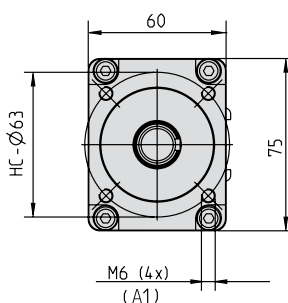
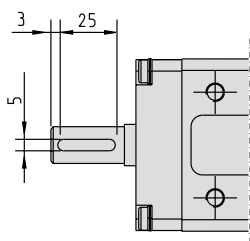

A1: depth 20

T90

T09SXXXXB25

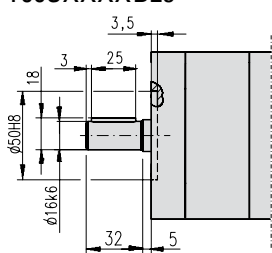

T09SXXXXH25

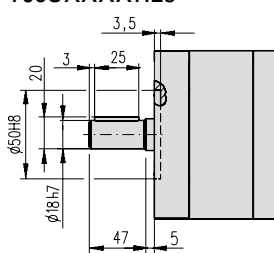

T09SXXXXB32

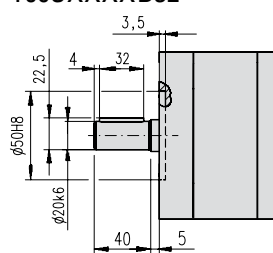

T09SXXXXL32

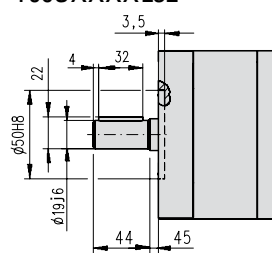

T09SXXXXB/H25

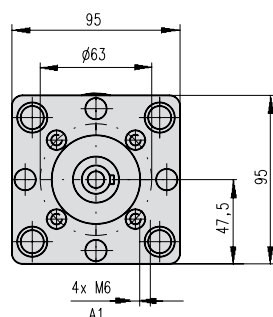
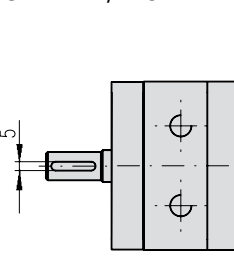

T09SXXXXB/L32

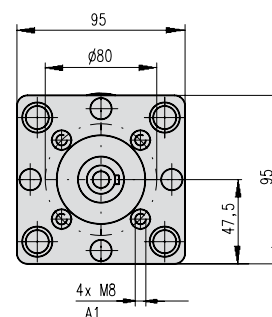
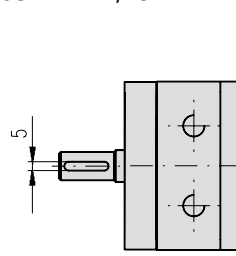

A1: depth 18

Options and Accessories

Shafts and Flanges for Non-RediMount™ Units

T130

T13SXXXXB40

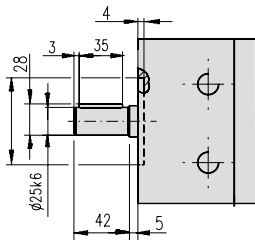

T13SXXXXL40

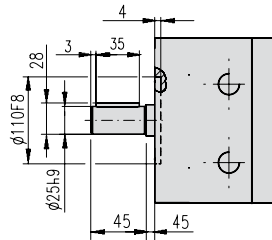

T13SXXXXB50

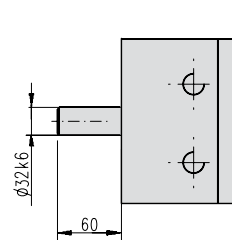

T13SXXXXK50

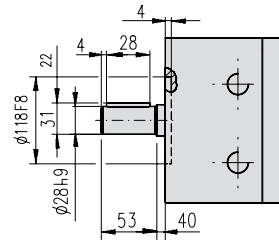

T13SXXXXB/L40

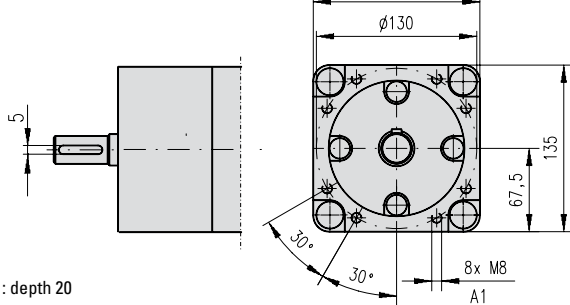

A1: depth 20

T13SXXXXB/K50*

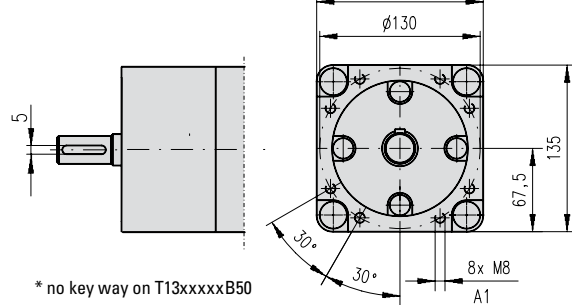

* no key way on T13xxxxxB50